

KIMOTO

MC Monitor Software

TSGraph

Operation Manual

KIMOTO ELECTRIC CO., LTD.

Abstract

We are delighted that you have decided to use KIMOTO's analyzers. TSGraph is a software that graphs data of KIMOTO's products (analyzers and data loggers) on PC screen. Also, the data can be stored in PC with a interval more than 1 second. Ethernet-HUB supporting 10/100 BASE-T should be necessary to communicate between KIMOTO's analyzers and PCs. Microsoft(R) Windows-based PC (7, Vista., XP) is needed to use the TSGraph.

This manual briefly describes the settings for Ethernet communication. If you have trouble in the Ethernet communication, please ask the people managing the network or ask people who knows better the Ethernet settings.

Contents

| | |
|-------------------------------------------------|---|
| 1. INSTALLATION | 1 |
| 2. NETWORK CONNECTION | 2 |
| 2.1 Ethernet setting of PC | 2 |
| 2.2 Connection between KIMOTO's analyzer and PC | 2 |
| 2.2.1 Connection using a cross cable | 2 |
| 2.2.2 Connection using a Ethernet HUB | 3 |
| 3. QUICK START | 4 |
| 3.1 Start of the TSGraph | 4 |
| 3.2 Connection to analyzers | 4 |
| 3.3 Selection of the display items | 4 |
| 4. ABOUT WINDOWS | 5 |
| 4.1 Main window | 5 |
| 4.2 File menu | 5 |
| 4.2.1 Record start | 5 |
| 4.2.2 Record stop | 5 |
| 4.2.3 Data save | 5 |
| 4.2.4 Save to bitmap | 5 |
| 4.2.5 Copy to clipboard | 5 |
| 4.2.6 Exit | 5 |
| 4.3 Graph settings | 5 |
| 4.3.1 Axis setting | 5 |
| 4.3.2 Data clear | 5 |
| 4.4 Tools | 6 |
| 4.4.1 Packet monitor | 6 |
| 4.4.2 Communication monitor | 6 |
| 4.4.3 Logging | 6 |
| 4.4.4 Options | 6 |
| 4.4.4.1 File | 6 |
| 4.4.4.2 Communication | 6 |
| 4.4.4.3 Graph axis | 7 |
| 4.4.4.4 Graph items | 7 |
| 4.5 VIEW | 7 |
| 4.6 Windows | 7 |
| 4.6.1 Sort | 7 |
| 5. APPENDIX | 8 |
| 5.1 Typical IP addresses of KIMOTO's analyzers | 8 |
| 5.2 Version | 8 |
| 5.3 Download site | 8 |

1. INSTALLATION

Start the installation process using install program "TSGraph2.exe". You can download the installer from our website. (see Sec.5.3.)

Wizard window appears when you run the install program. Install the TSGraph following the instructions on the screen.

After the installation finishes, you will find the icon of the TSGraph on the desktop. Also, the TSGraph can be started from "Start" button -> "Programs" -> "Kimoto Utils" -> "TSGraph" as below.

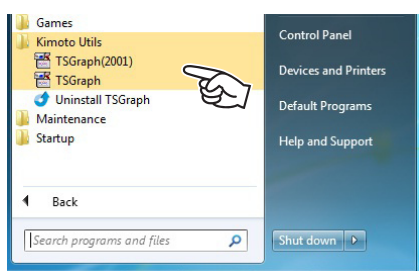

*) How to start two or more TSGraphs

You can use ten TSGraphs simultaneously on a single PC.

The Ethernet port number can be manually set by using "/port" argument.

You can use the port from No. 2000 to No. 2009.

Refer to the shortcut "TSGraph(2001)" registered in the start menu as an example.

2. NETWORK CONNECTION

All KIMOTO's analyzers uses the Ethernet for the communication with PCs. You can easily download the data to your PC via Ethernet. It may need some networking knowledge and administrative privileges of Windows in order to setup the software. If you have any trouble to setup, please ask a network administrator or people managing the network.

2.1 Ethernet setting of PC

It is necessary to setup Ethernet connection of your PC before data communication. All our analyzers manufactured after December 2005 have dynamic host configuration protocol (DHCP) that assigns IP addresses automatically. For other analyzers manufactured before December 2005, it is needed to manually setup the IP address and subnet mask.

For example (manual setting);
 IP address: 192. 168. 0. 10
 Subnet mask: 255. 255. 255. 0

2.2 Connection between KIMOTO's analyzer and PC

There are two ways for communication between our analyzers and PCs. One is one-to-one communication using a cross-cable. Another is multiaccess communications using the Ethernet HUB.

2.2.1 Connection using a cross cable

The following figure shows a connection using a crossover Ethernet cable. Sometimes the connection cannot be established because of specification of the PC. In that case, it is recommended to use HUB as shown in section 2.2.2.

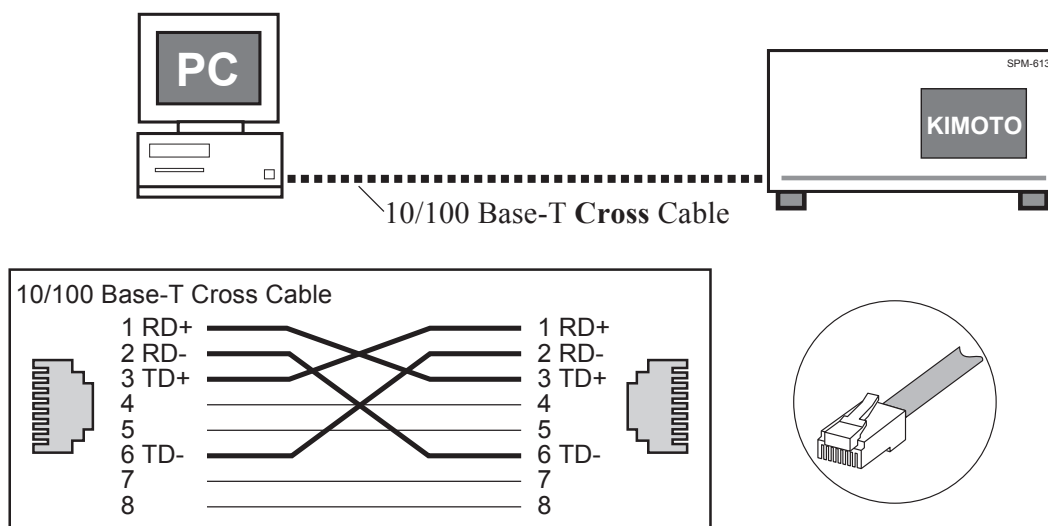

2.2.2 Connection using a Ethernet HUB

The following figure shows a connection using Ethernet HUB and straight cables. By using a HUB, you can set a single PC communicating simultaneously with multiple analyzers.

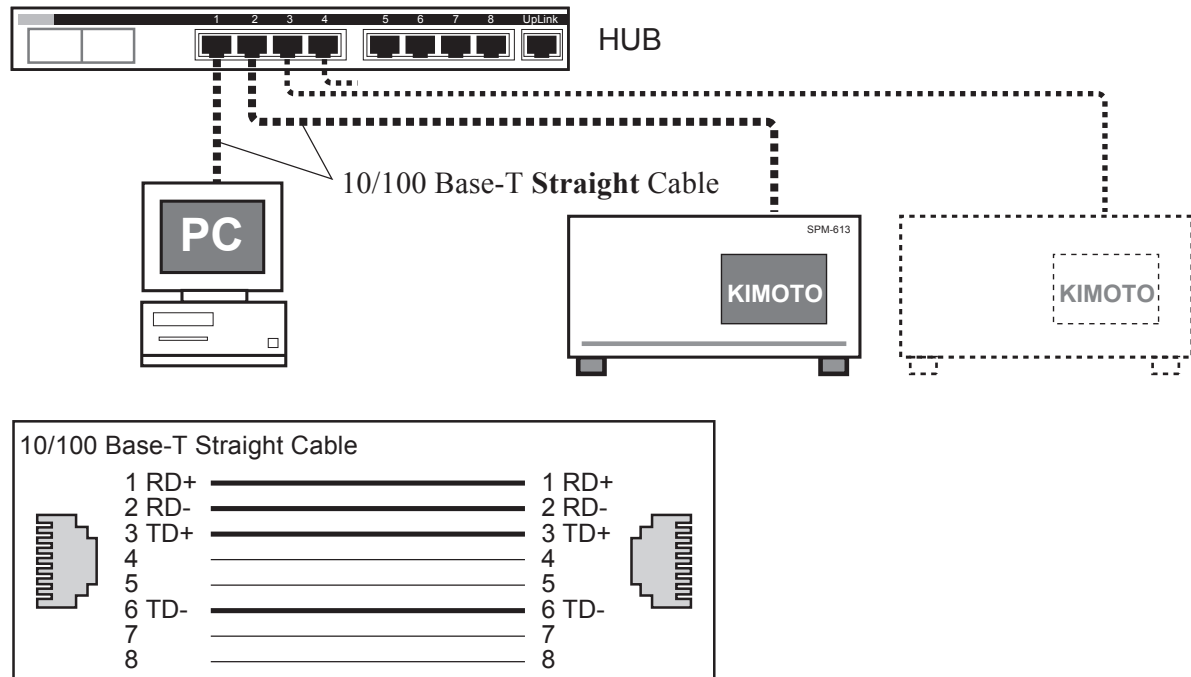

3. QUICK START

3.1 Start of the TSGraph

Start the TSGraph from the "Start menu" or from the shortcut icon.

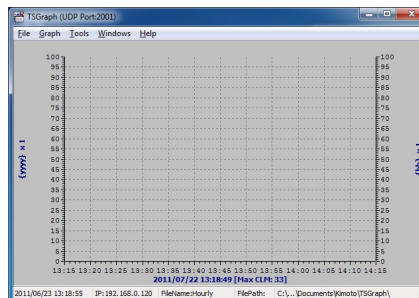

3.2 Connection to analyzers

- 1) Click "Tool" -> "Option" -> "Communication".
- 2) Click "MC series" button.
Then, a dialog box for selection of connecting analyzers is displayed. In this dialog box, IP address can be set manually, or be set by selecting from the pull-down menu.
- 3) Click "OK" button (*).

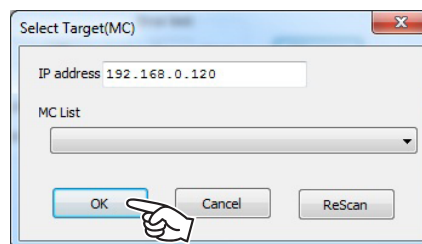
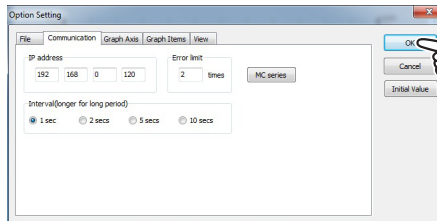

3.3 Selection of the display items

- 1) Click "Tool" --> "Option" --> "Graph Items".
- 2) Click the box of the "Item". Then a dialog box of the item selection is displayed.
- 3) Select the item to be displayed from the pull-down menu and click [OK].
Repeat steps (2) and (3) for other items you would like to display.
Select the width and the color of the line.
Check the checkbox of the item to be displayed.

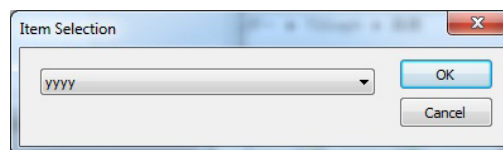
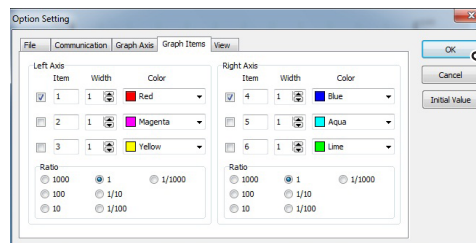

(* If the OS is Windows 7 or Windows Vista, "Windows Security Alert" window may appear after you click "OK" button. In order to allow communication with your analyzer, check-off all boxes and click "Allow Access" button on the window. For this change, administrative privileges are required to allow access.

4.ABOUT WINDOWS

4.1 Main window

1) Tool bar

2) Graph area

Displays a graph.

The graph can be zoomed in by the following operations.

Mouse drag from upper left to lower right: Zoom in the selected part

Mouse drag from lower right to upper left: Deactivates the zoom-in

3) Status bar:

Displays Time, IP, FileName and FilePath.

Time : Internal clock time of the connected analyzer

IP : IP address of the connected analyzer

FileName : File name change interval (e.g. "Hourly")

FilePath : File path of the saved data

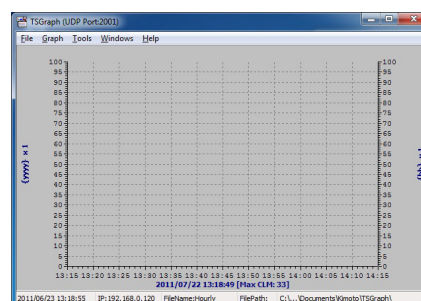

4.2 File menu

4.2.1 Record start

Starts the recording to the CSV file.

4.2.2 Record stop

Stops the recording to the CSV file.

4.2.3 Data save

Saves data buffered in the memory to the CSV file.

4.2.4 Save to bitmap

Saves a present graph image as bitmap.

4.2.5 Copy to clipboard

Copies a present graph image to the clipboard.

4.2.6 Exit

Ends TSGraph.

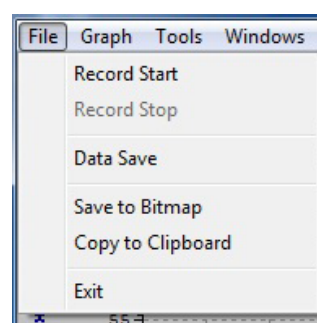

4.3. Graph settings

4.3.1 Axis setting

The scales of the time axis, the left axis, and the right axis can be set.

4.3.2 Data clear

All the buffered data of the graph are cleared.

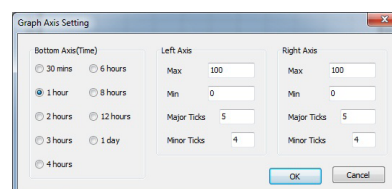
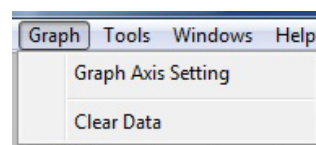

4.4 Tools

4.4.1 Packet monitor

The packet data sent from the analyzer is displayed.

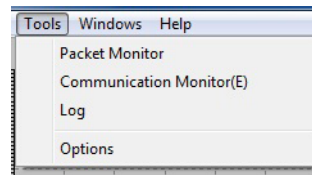

4.4.2 Communication monitor

The communication data strings sent from the analyzer are displayed.

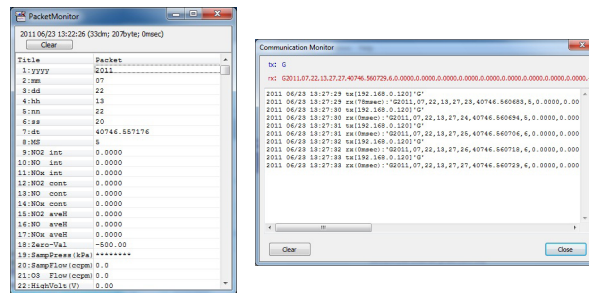

4.4.3 Logging

The log of operations (e.g., program start and stop) is displayed.

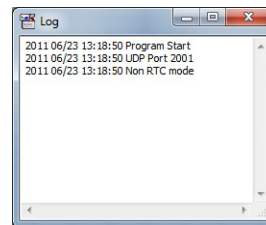

4.4.4 Options

4.4.4.1 File

File Path :

Path to the saved data

Record Interval :

This is not the display interval of the monitor, but the interval of data recording to the file.

(This option is valid only when the communication interval is set to one second.)

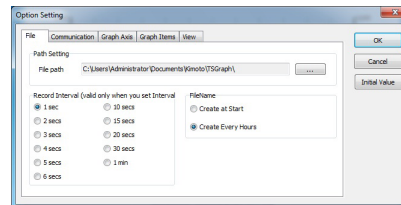

FileName :

Create at Start :

Data from the start to the stop are saved in one file.

Create Every Hours :

Data for one hour are saved in one file.

4.4.4.2 Communication

IP address :

Input IP address of the analyzer to be connected. It is also possible to select IP address from the pull-down menu by clicking "MC series" button.

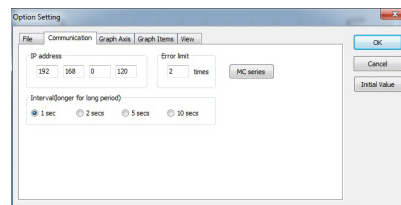

Interval :

Select the communication interval between the analyzer and PC.

Select "1 sec" for normal operation.

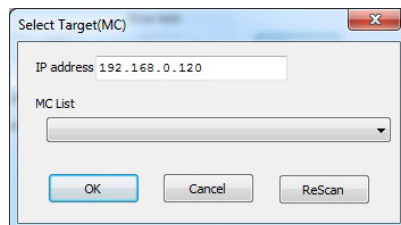

Error limit :

The retrying number of times when communication error occurs.

4.4.4.3 Graph axis

Bottom Axis : Set the scale of the time axis.

Left Axis :

Set the scale and the scale interval of the left axis.

Right Axis :

Set the scale and the scale interval of the right axis.

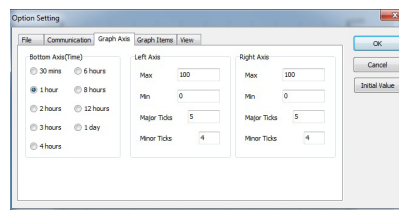

4.4.4.4 Graph items

Left Axis

Checkbox :

The checked items are displayed on the screen.

Item :

Double-click here. And, select the item to be displayed.

Width : Select the line width of the graph.

Color : Select the line color of the graph.

Scaling ratio :

Select the scaling ratio of the data. The data value multiplied with this ratio is used in the graph.

Right Axis

Same as Left Axis.

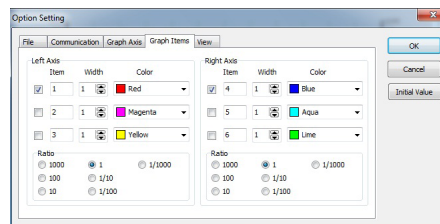

4.5 VIEW

Show Legend :

Check this to show the graph legend.

Position : Select the position of the graph legend.

Show Item name for Y axis :

Check this to display actual item names in the item axis (Y axis).

Show data for Y axis :

Check this to display measurement values in the item axis (Y axis).

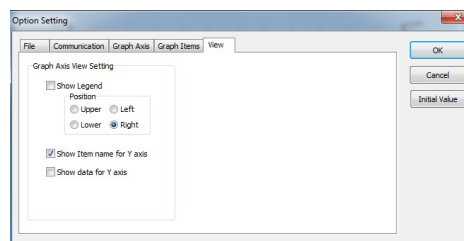

4.6 Windows

4.6.1 Sort

This can set sizes of TSGraphs.

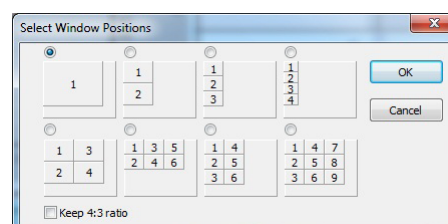
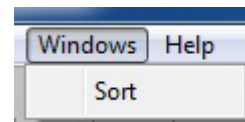

5. APPENDIX

5.1 Typical IP addresses of KIMOTO's analyzers

| | |
|----------------------------|---------------|
| Data Logger | 192.168.0.110 |
| Nitrogen Oxides Analyzer | 192.168.0.120 |
| Ozone Analyzer | 192.168.0.130 |
| Sulfur Dioxide Analyzer | 192.168.0.140 |
| Particulate Matter Monitor | 192.168.0.150 |

5.2 Version

Select "Help"-->"About" pull-down menu to see the version information of the TSGraph.

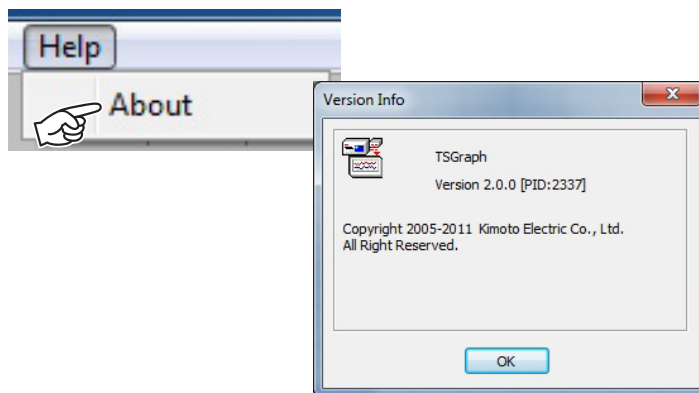

5.3 Download site

The latest installer is located on the web site at;

<http://www.kimoto-electric.co.jp/support/index.html>

This manual is applicable for the following versions of the software.

PID 2337 Ver.2.0.0 or later

人・社会・自然の関わりをはかる

KIMOTO

紀本電子工業株式会社

本社・工場 大阪市天王寺区舟橋町3-1 〒543-0024

TEL: 06-6768-3401

FAX: 06-6764-7040

URL: <http://www.kimoto-electric.co.jp/>

E-mail: sales@kimoto-electric.co.jp

東京営業所 東京都品川区南大井3-23-12 〒140-0013

TEL: 03-3761-8191

FAX: 03-3761-8294